

Do you feel what I feel? (Social Aspects of Sentiments and Emotions in Twitter Conversations)

Submitted to CHI 2012

by Suin Kim, Jinyeong Bak, Yohan Jo, and
Alice Oh

alice.oh@kaist.edu

<http://uilab.kaist.ac.kr>

Attending ACL 2012? Come to KAIST!

8~13 hr flight



- JFK
- IAD
- ATL
- ORD
- SFO
- SEA
- LAX

Users & Information Lab at KAIST

- Topic Modeling
- Sentiment Analysis
- Social Media Analysis

Social Aspects of Emotions: Research Questions

- How do we communicate our emotions?
- How do we influence other people's emotions?

Social Aspects of Emotions: Data

- Twitter conversation data: approx 300k dyads who “reply” to each other

1  **aliceoh** Alice Oh
Our paper w/ @arongdari "Accounting for Data Dependencies within a Hierarchical Dirichlet Process Mixture Model" accepted #cikm2011
20 Jul ☆ Favorite ↶ Reply 🗑 Delete

in reply to ↑

2  **@ArjumandYounus**
ArjumandYounus

@aliceoh @arongdari Sounds pretty cool, I am working on LDA these days. Could you send me a pre-print version of the paper?

3  **aliceoh** Alice Oh
@ArjumandYounus @arongdari We'll have a camera-ready in a couple of weeks. If you'd like a copy as is now, send email to dw.kim@kaist.ac.kr
21 Jul ☆ Favorite ↶ Reply 🗑 Delete

in reply to ↑

4  **@ArjumandYounus**
ArjumandYounus

@aliceoh @arongdari I need a copy now, since some ideas are fresh. I'll email soon for a copy.

Social Aspects of Emotions: Model

Aspect Sentiment Unification Model

(Yohan Jo & Alice Oh, WSDM 2011)

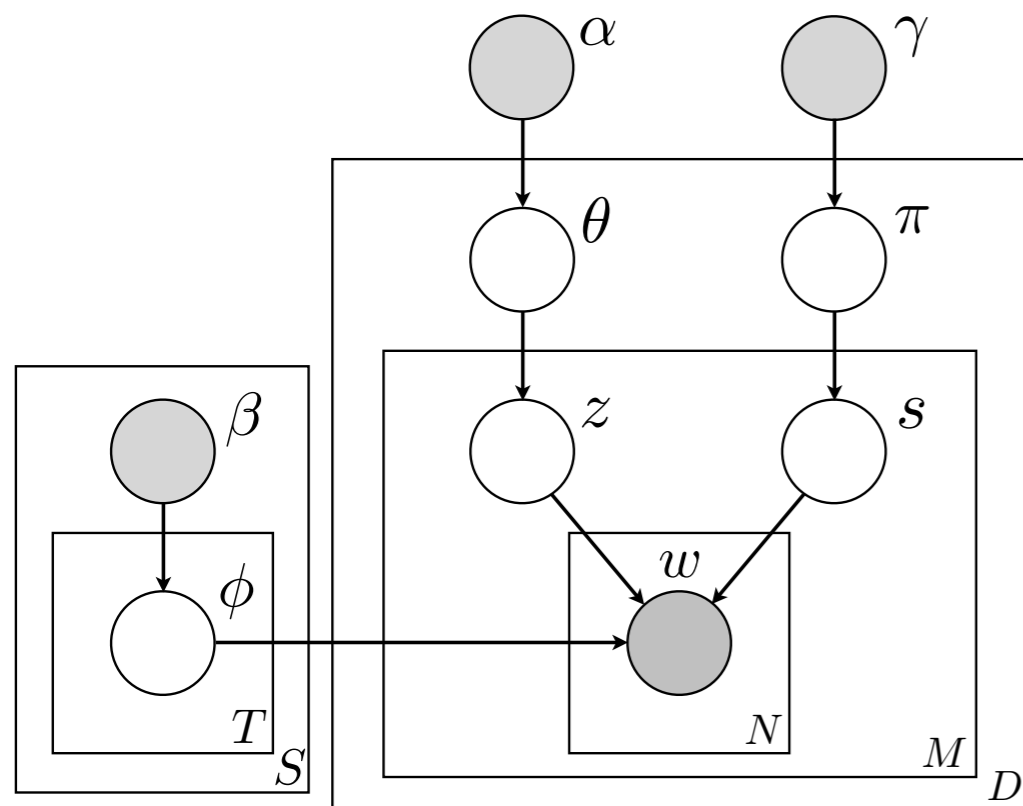

(b) ASUM

topic	positive	negative
mp3 player	great featur good screen love listen better new well sound record	comput sync media cd transfer load album playlist time format drag folder
restaurant service	great good nice attent excel experi atmospher amaz help top awesom quick	onli park slow suck bad horribl just complaint star rude terribl long
laptop screen	bright view clear resolut see nice led small good sharp read crisp	macbook appl reflect glare matt new pro problem firewir machin laptop issu

Social Aspects of Emotions: Defining Emotions

Primary Emotion	Secondary Emotion
Love	Affection, Lust, Longing
Joy	Cheerfulness, Zest, Contentment, Pride, Optimism, Enthrallment, Relief
Surprise	Surprise
Anger	Irritation, Exasperation, Rage, Disgust, Envy, Torment
Sadness	Suffering, Sadness, Disappointment, Shame, Neglect
Fear	Horror, Nervousness

Table 3. Parrot's tree-structured list of emotions

Social Aspects of Emotions: Research Questions

- How do we communicate our emotions?
 - Use ASUM on Twitter conversations to discover the “topics” that represent the +/n/- sentiments and the six primary emotions
 - Analyze the proportions of the total tweets for the sentiments and emotions
- How do we influence other people’s emotions?
 - Analyze the sentiment and emotion transitions of the tweets
 - Look for topics that change the sentiments and emotions of the conversation partners
 - Find interesting patterns of sentiment and emotion topic pairs

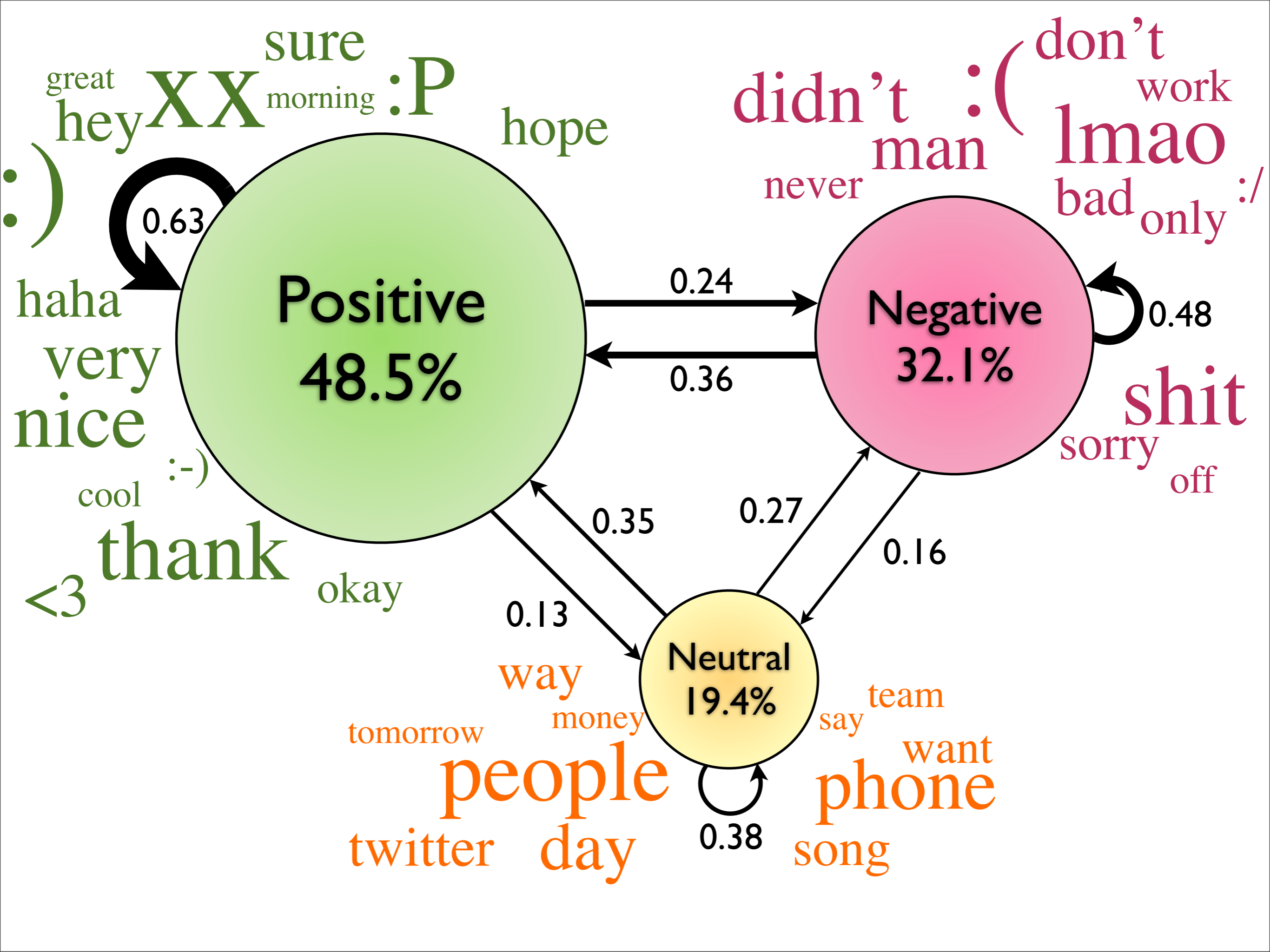

Emotion Topics

Joy

Topic 31

day
hope
morning
great
weekend

Topic 23

party
home
fun
tomorrow

Topic 40

happy
birthday
th
hahaha
year

Topic 46

thank
much
very
hope

Sadness

Topic 99

hope
sorry
better
feel
soon
aww
okay
hugs
feeling
happened

Topic 86

:'
miss
him
sorry
want
sad
wish
wanna
much
cry

Love

Topic 1

her
smiles
laughs
eyes
want
Topic 47
school
luck
exam
tomorrow

Topic 3

twitter
justin
follow
selena
fan

Topic 9

pic
hair
look
nice

Fear

Topic 60

:/
school
tomorrow
exam
year
doing
much
day
next
maths

Topic 87

dont
lmao
tell
want
him
her
please
face
who
omg

Anger

Topic 95

eat
want
food
chicken
hungry
Topic 73
she
hate
being
never

Topic 59

she
:(
car
were
off
home
her
phone
house
night

Surprise

Topic 18

song
album
music
new
her
she
amazing
listening
awesome
great

Topic 30

where
live
here
same
awesome
Topic 68
she
old
than
look

Emotion Transitions

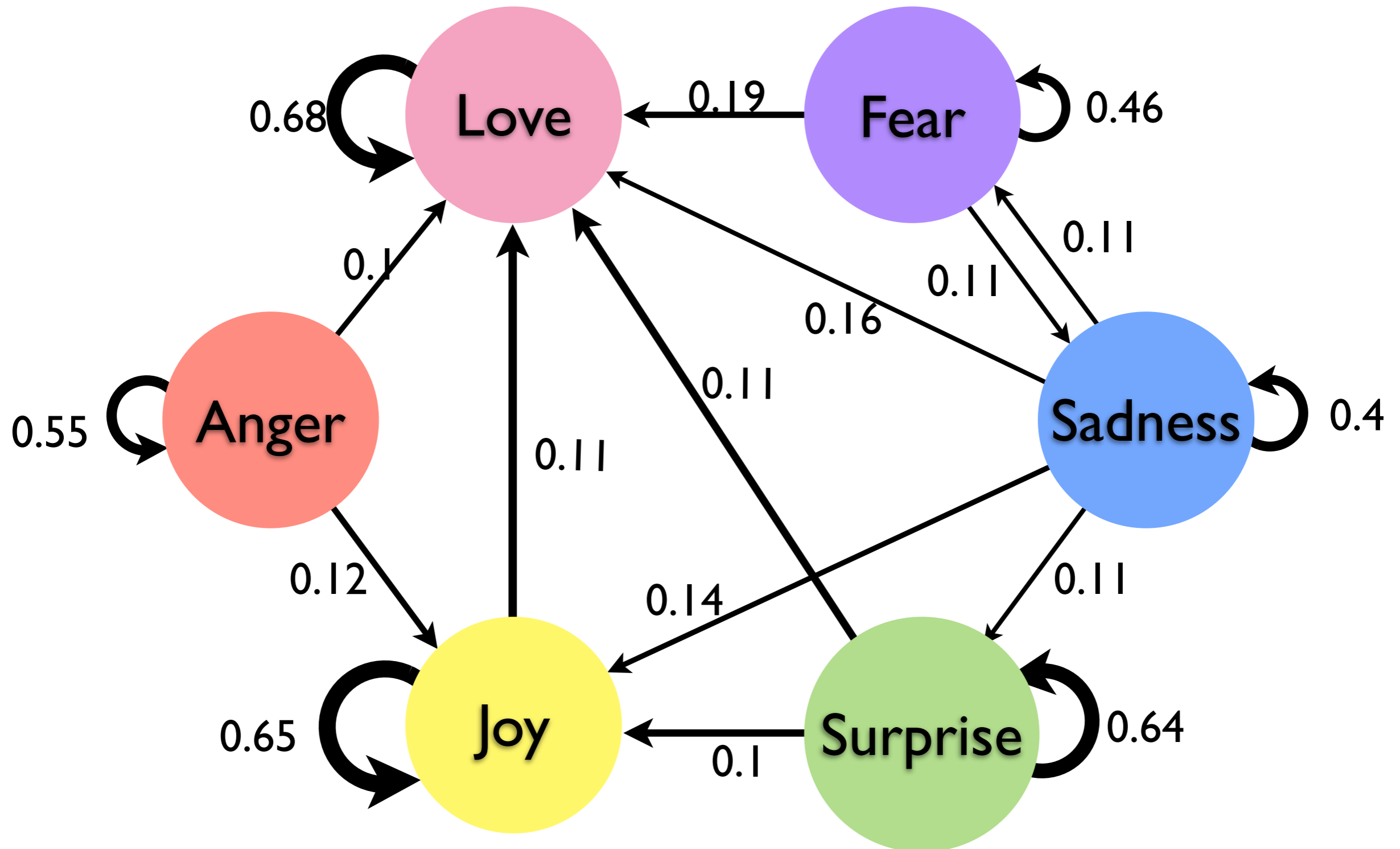

Defining “Influence”

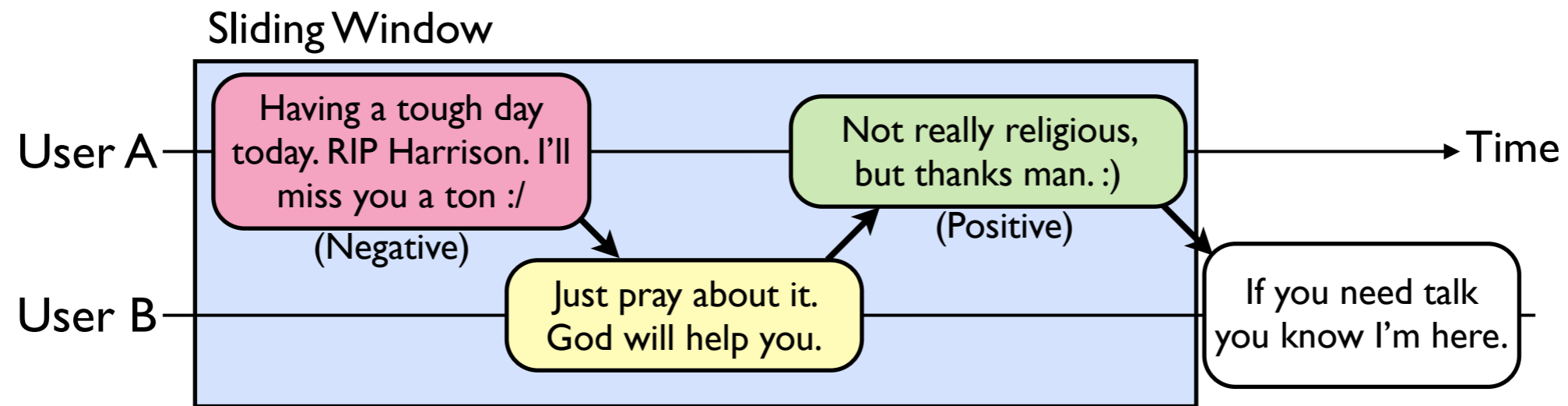

Topics that Influence Sentiment

Positive → Positive

Topic 16

follow
thank
please
followed
welcome

Topic 8

thank
:D
much
very
welcome

Topic 19

heart
xD
big
kisses
much

Topic 21

morning
day
hope
hello
happy

Positive → Negative

Topic 17

lmao
ur
ass
lol
shit

Topic 48

weather
rain
:(
hot
cold

Topic 38

:(
school
exam
tomorrow
year

Topic 54

sleep
work
still
awake
tired

Negative → Positive

Topic 44

hope
better
sorry
feel
soon

Topic 59

home
want
house
sleep
bed

Topic 47

today
week
still
feel
work

Topic 37

money
buy
want
had
pay

Negative → Negative

Topic 72

shit
bro
da
chillin
nigga

Topic 49

game
lmao
shit
team
win

Topic 42

off
still
bad
feel
down

Topic 32

ur
loool
lool
loool
man

Topics that Influence Emotions

Anger → Joy

Topic 23

day
night
party
home
fun
come

Topic 23

night
party
home
fun
tomorrow

Topic 17

eat
food
cream
make
chocolate
drink

dr

Topic 46

:)
thank
much
very
hope

Sadness → Joy

Topic 81

better
feel
hope
pain
sick
:(

Topic 99

hope
sorry
better
feel
soon
hugs

Surprise

→ Love

Topic 18

song
album
amazing
listening
great

→ Anger

Topic 79

song
shit
new
lmao
never

Sentiment Patterns of Dyads

28,715 chains / 17.0%

Positive ↔ Positive

Topic 13

xx
okay
thank
<3
welcome
Topic 31
day
hope
morning
great
today

Topic 40

happy
birthday
th
xx
hahaha
Topic 14
follow
please
followed
:D
thank

6,778 chains / 4.02%

Positive ↔ Negative

Topic 65

same
thing
never
bad
ever
Topic 26
watch
movie
seen
film
season

Topic 86

miss
:'(
him
sorry
sad
Topic 69
work
day
:(
week
today

19,227 chains / 11.4%

Negative ↔ Negative

Topic 63

lmao
shit
yu
ass
nigga
Topic 66
iphone
:(
android
battery
screen

Topic 91

game
team
play
still
fuck
Topic 79
song
she
shit
new
lmao

Complaint-Apology Pattern

A: Sorry to hear about your bags. If you would like us to get someone to contact you DM us your reference and contact number.

B: it's on it's way to manch. If the woman on the check in desk in Miami hadn't been trying to be all smart! Been no problem.

A: Sorry about that. Pleased to hear they located it quickly for you though.

B: mistakes happen.

Email me for collaborations, data exchanges,
student exchanges, visiting Korea

alice.oh@kaist.edu

<http://uilab.kaist.ac.kr>